

6" x 9" 3-Way Speaker 400 W MAX.



Key Selling Point

- Deeper bass and clearer high frequencies sound reproduction is realized with higher dynamic range for greater listening experiences.
- With the balanced combination of the parts, higher power handling ability is realized for more impactful sound and vibrant music playback (Max Power increased for TS-A1676S and 6" x 9" models).
- High-quality appearance and universal design enhance the vehicle interior. High durability can withstand even severe use (fully covered mesh grille included for 6" x 9" models).

Speaker Technology

Progressive Flex Suspension System (P.F.S.S. patented technology, for 6" x 9" models and TS-A1686S)

With exclusive material inherited from Pioneer's high-end PRS Series, this system realizes ideal sound reproduction. At a small input, its soft part makes movement smooth and reproduces clear sound and at excessive input, its hard part controls excessive vibration and prevents movement error.

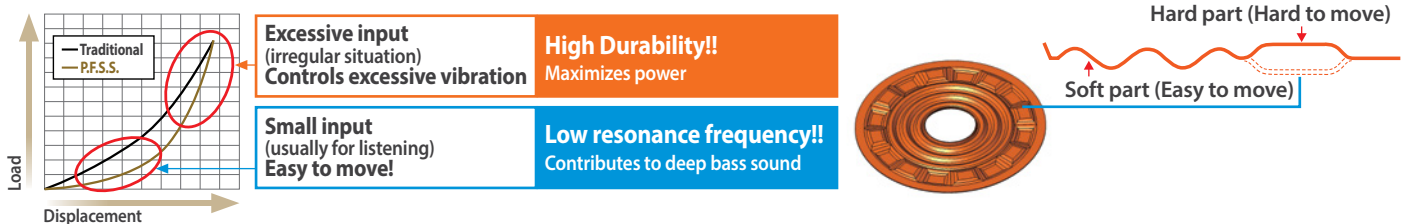

Cut View

Increased Max Power

Max music power resulting from the combination of optimized parts (indicated by red letters on the diagram below) exceeds the power of the previous A Series models.

Note: The following explanations are not for TS-A2013i and TS-A2503i.

Example	Previous	TS-A6995S (600 W MAX.)	→	New	TS-A6996S (650 W MAX.)
	Previous	TS-A1675S (300 W MAX.)	→	New	TS-A1676S (320 W MAX.)

Tweeter with Direct Drive Diaphragm (TS-A6996S & TS-A6986S)

Hard Type Direct Drive Diaphragm

TS-A6996S TS-A6986S

Prevents deformation caused by excessive input.

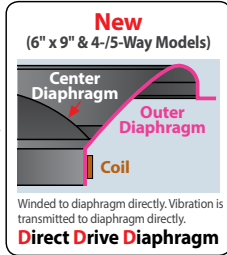
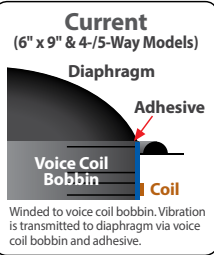

High Sensitivity & Flat-Response

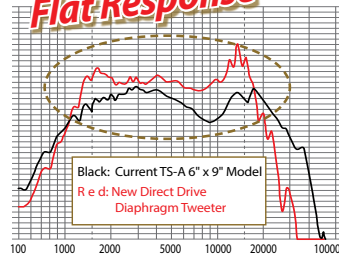

Extended High Frequency Range

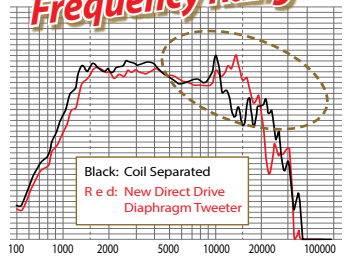

Multilayer Mica Matrix Cone

All Models

Consistently maintains bass quality even at high input.

Elastic Polymer Surround

P.F.S.S. Spider

TS-A1606C TS-A6996S TS-A6986S TS-A6976S
TS-A6966S TS-A1686S

Achieves the best balance between sound quality and high durability. This system realizes ideal sound reproduction.

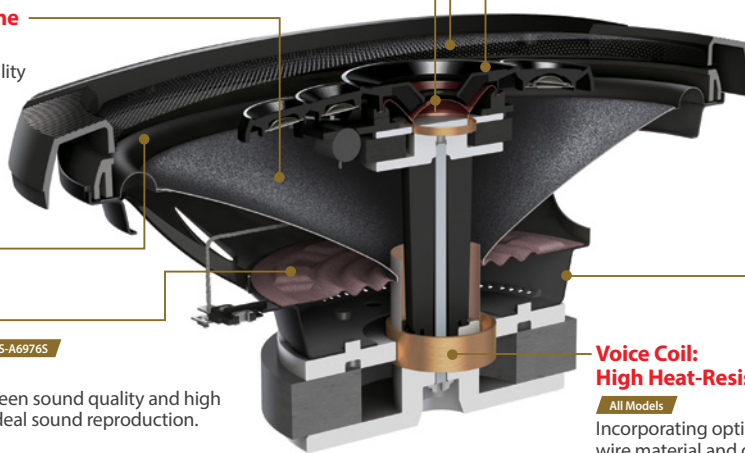

Quality Design Grille & Flange

Cooling Basket with Air Vents

TS-A6996S TS-A6986S TS-A6976S TS-A6966S

Air vents under the spider make movement smooth and cool the body.

Fully Covered Mesh Grille for 6" x 9" Models



Prevents dust from entering speaker body interior.

Voice Coil: High Heat-Resistant Wire

All Models

Incorporating optimized wire material and diameter.

Main Specifications

Max input	Nominal Input	Frequency Response	Sensitivity	Impedance	Size	Tweeter size
400 W	60 W	35 Hz to 37 KHz	92dB	4Ω	6 X 9	11 mm

Dimension

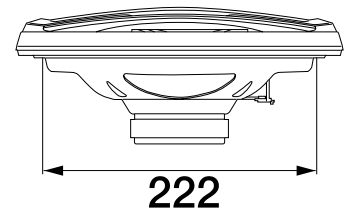
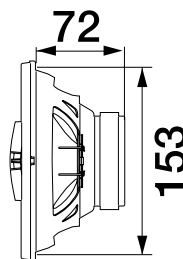
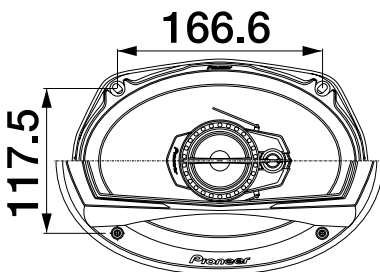

For more information please visit
www.pioneer-mea.com

Year of Release: 2016

Pioneer, Gulf Free Zone Dubai, U.A.E.
Tel: +971 4 8815756, Fax 8816414
Email: support@pioneer-uae.com
www.pioneer-mea.com

Corporate web : www.pioneer.jp

Copyright Info: ©2016 Pioneer MEA. All Rights Reserved. Reproduction in whole or in part without written permission is prohibited. Design, Features and Specifications are subject to change without notice.



884938187657