

6" x 9" 3-Way Speaker **450 W MAX.**



## Key Selling Point

- Deeper bass and clearer high frequencies sound reproduction is realized with higher dynamic range for greater listening experiences.
- With the balanced combination of the parts, higher power handling ability is realized for more impactful sound and vibrant music playback (Max Power increased for TS-A1676S and 6" x 9" models).
- High-quality appearance and universal design enhance the vehicle interior. High durability can withstand even severe use (fully covered mesh grille included for 6" x 9" models).

## Speaker Technology

### Progressive Flex Suspension System (P.F.S.S. patented technology, for 6" x 9" models and TS-A1686S)

With exclusive material inherited from Pioneer's high-end PRS Series, this system realizes ideal sound reproduction. At a small input, its soft part makes movement smooth and reproduces clear sound and at excessive input, its hard part controls excessive vibration and prevents movement error.

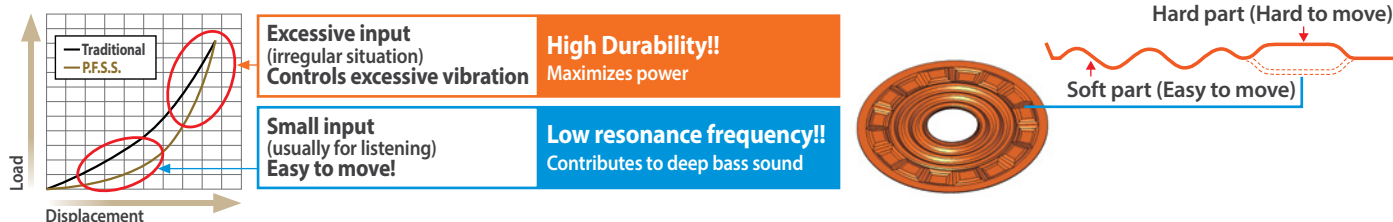

# Cut View

## Increased Max Power

Max music power resulting from the combination of optimized parts (indicated by red letters on the diagram below) exceeds the power of the previous A Series models.

Note: The following explanations are not for TS-A2013i and TS-A2503i.

Example	Previous	TS-A6995S (600 W MAX.)	→	New	TS-A6996S (650 W MAX.)
	Previous	TS-A1675S (300 W MAX.)	→	New	TS-A1676S (320 W MAX.)

### Tweeter with Direct Drive Diaphragm (TS-A6996S & TS-A6986S)

#### Hard Type Direct Drive Diaphragm

TS-A6996S TS-A6986S

Prevents deformation caused by excessive input.

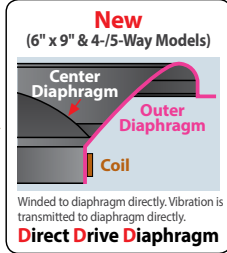
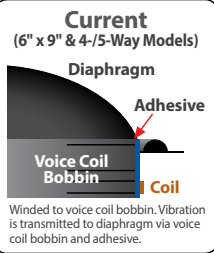

### High Sensitivity & Flat-Response

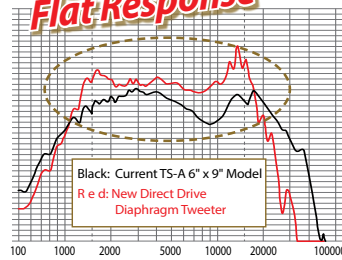

### Extended High Frequency Range

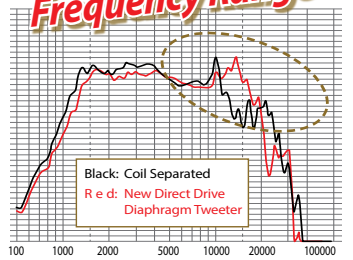

#### Multilayer Mica Matrix Cone

All Models

Consistently maintains bass quality even at high input.

#### Elastic Polymer Surround

#### P.F.S.S. Spider

TS-A1606C TS-A6996S TS-A6986S TS-A6976S  
TS-A6966S TS-A1686S

Achieves the best balance between sound quality and high durability. This system realizes ideal sound reproduction.

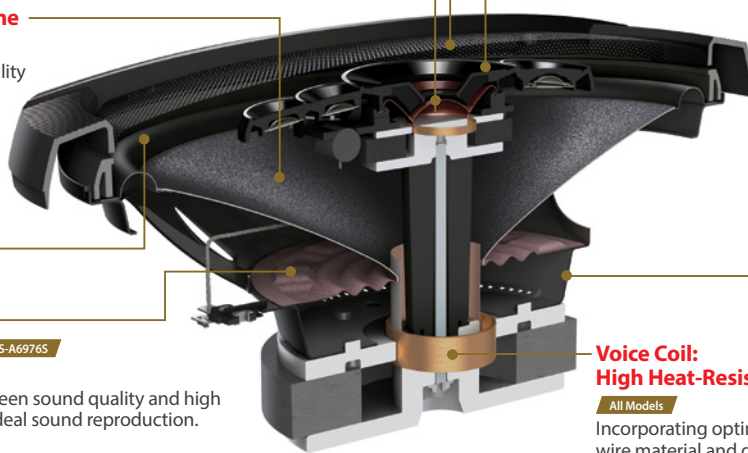

#### Quality Design Grille & Flange

#### Cooling Basket with Air Vents

TS-A6996S TS-A6986S TS-A6976S TS-A6966S

Air vents under the spider make movement smooth and cool the body.

#### Fully Covered Mesh Grille for 6" x 9" Models



Prevents dust from entering speaker body interior.

#### Voice Coil: High Heat-Resistant Wire

All Models

Incorporating optimized wire material and diameter.

## Main Specifications

Max input	Nominal Input	Frequency Response	Sensitivity	Impedance	Size
420 W	60 W	28 Hz to 36 KHz	92dB	4Ω	6 X 9

## Dimension

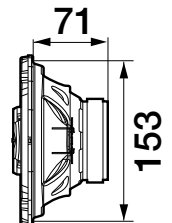
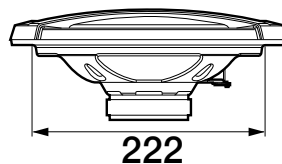
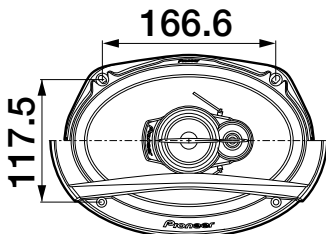

For more information please visit  
[www.pioneer-mea.com](http://www.pioneer-mea.com)

Year of Release: 2016

Pioneer, Gulf Free Zone Dubai, U.A.E.  
Tel: +971 4 8815756, Fax 8816414  
Email: support@pioneer-uae.com  
[www.pioneer-mea.com](http://www.pioneer-mea.com)

Corporate web : [www.pioneer.jp](http://www.pioneer.jp)

Copyright Info: ©2016 Pioneer MEA. All Rights Reserved. Reproduction in whole or in part without written permission is prohibited. Design, Features and Specifications are subject to change without notice.



884938311625