

13 cm 2-Way Speaker 250 W MAX.



Key Selling Point

- Mica-reinforced IMPP cone reproduces natural sound with impressive bass.
- Shallow mounting depth and comprehensive lineup allow for wide applications.
- Universal cosmetic design suits a variety of automobile interior colors.

Speaker Technology

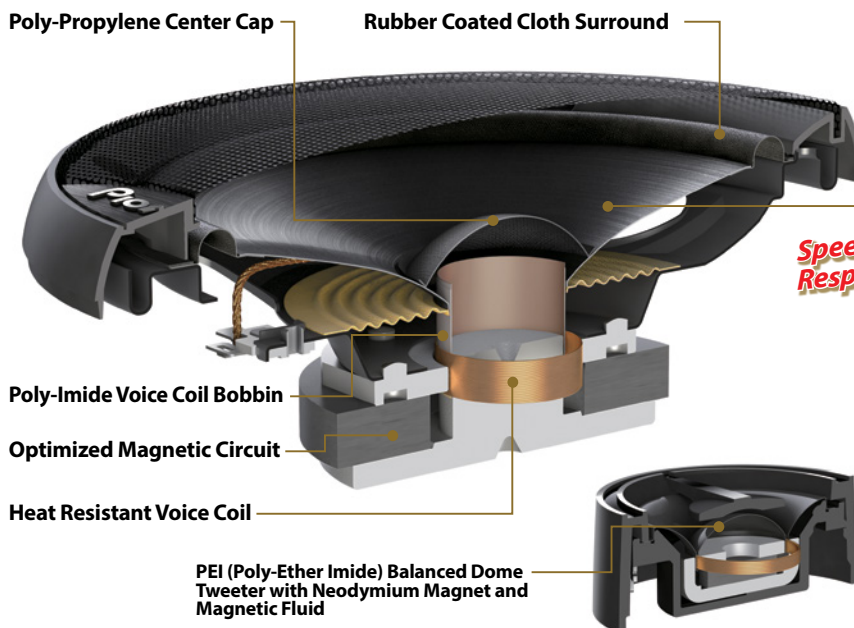

Mica Reinforced IMPP Cone

The mica is mixed into the cone material in precise proportions to optimize cone rigidity and to reproduce impactful bass.

Speedy Response!

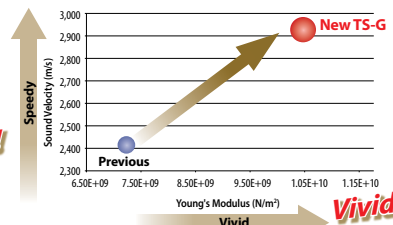

Vivid Sound!

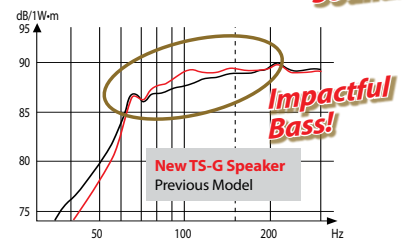

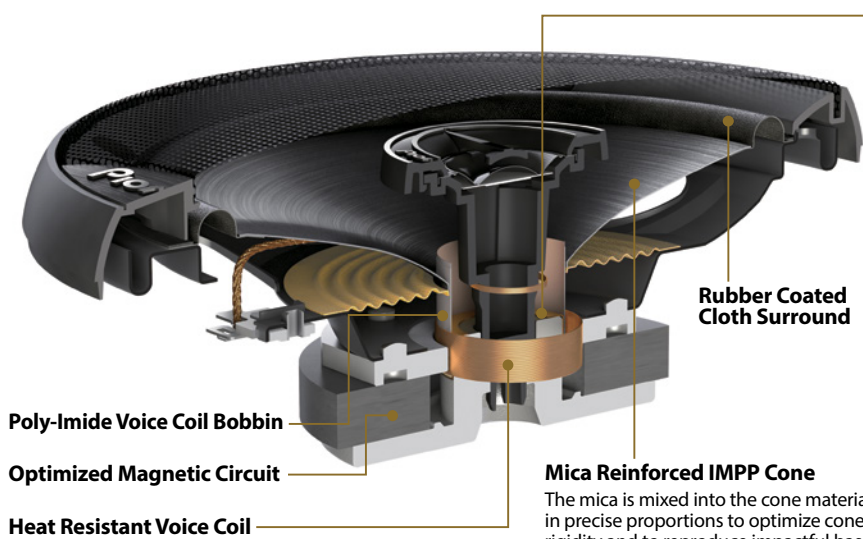

OFC Short Ring

Reduces a distortion, and expands a high frequency range.

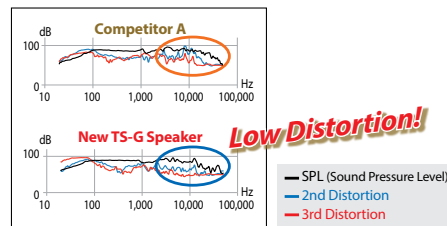

Mica Reinforced IMPP Cone
The mica is mixed into the cone material in precise proportions to optimize cone rigidity and to reproduce impactful bass.

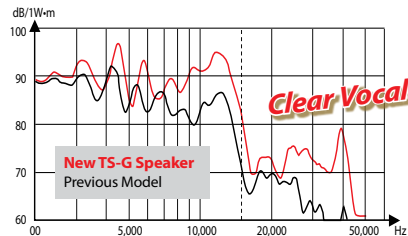

Main Specifications

Max music power output	Nominal music power output	Frequency Response	Sensitivity	Impedance	Size
250 W	35 W	34 Hz to 25 KHz	86 dB	4Ω	13cm

Dimension

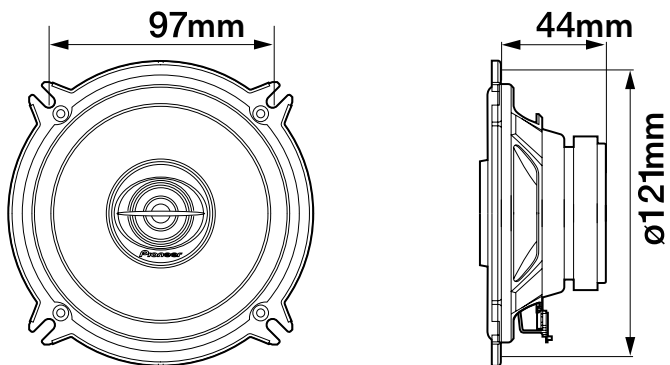

For more information please visit www.pioneer-mea.com

Year of Release: 2016

Pioneer, Gulf Free Zone Dubai, U.A.E.
Tel: +971 4 8815756, Fax 8816414
Email: support@pioneer-uae.com
www.pioneer-mea.com

Corporate web : www.pioneer.jp



Copyright Info: ©2016 Pioneer MEA. All Rights Reserved. Reproduction in whole or in part without written permission is prohibited. Design, Features and Specifications are subject to change without notice.