

16 cm Dual cone speaker 230 W MAX.



**Key Selling Point**

- Mica-reinforced IMPP cone reproduces natural sound with impressive bass.
- Shallow mounting depth and comprehensive lineup allow for wide applications.
- Universal cosmetic design suits a variety of automobile interior colors.

**Speaker Technology**

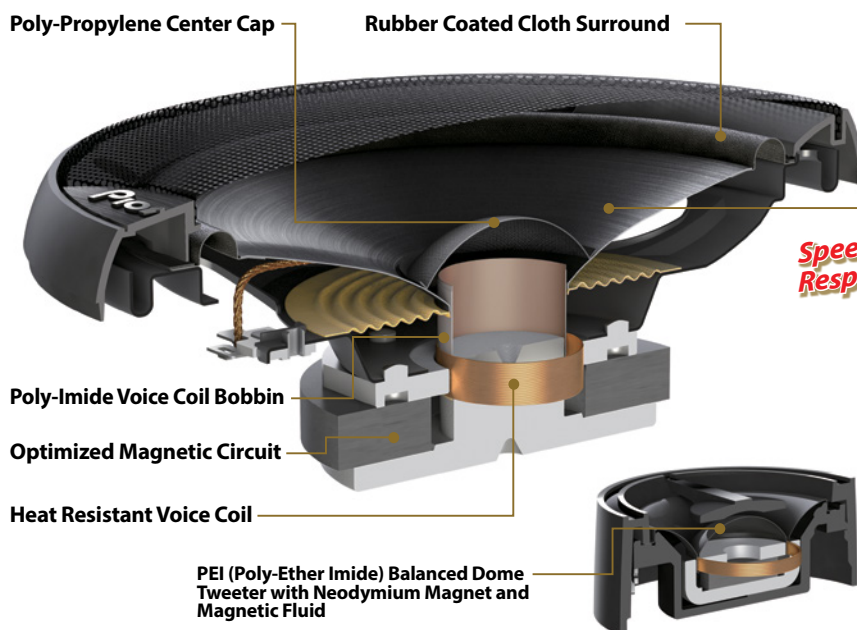

**Mica Reinforced IMPP Cone**

The mica is mixed into the cone material in precise proportions to optimize cone rigidity and to reproduce impactful bass.

*Speedy Response!*

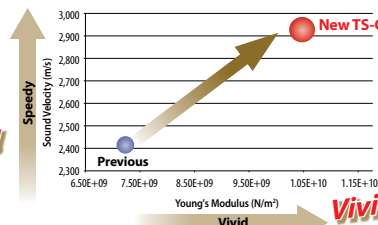

*Vivid Sound!*

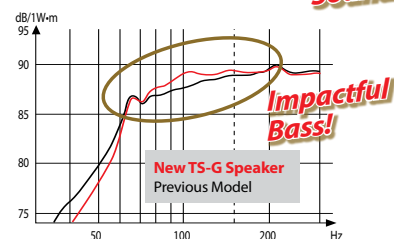

*Impactful Bass!*

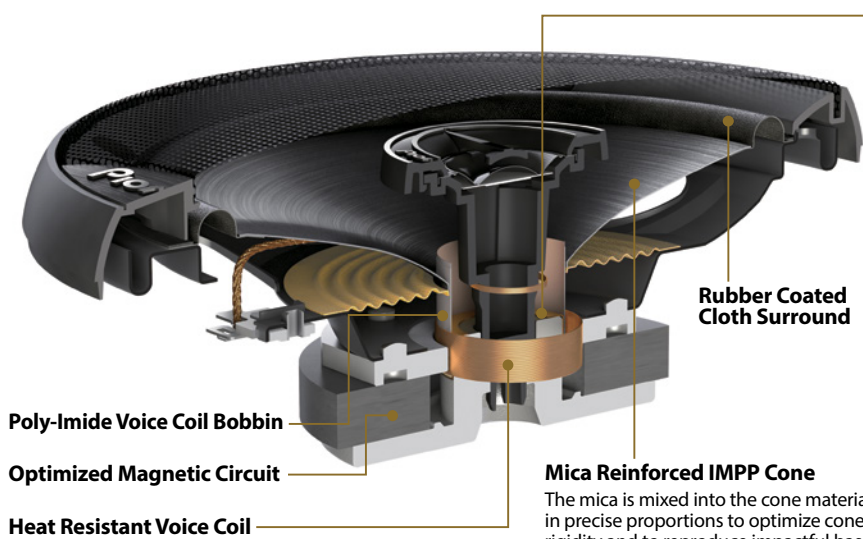

### OFC Short Ring

Reduces a distortion, and expands a high frequency range.

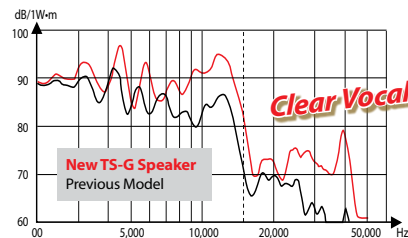
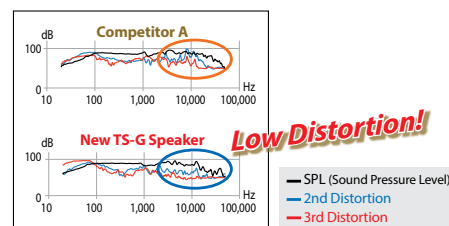

## Main Specifications

Max music power output	Nominal music power output	Frequency Response	Sensitivity	Impedance	Size
230 W	40 W	30 Hz to 25 KHz	90 dB	4Ω	16cm

## Dimension

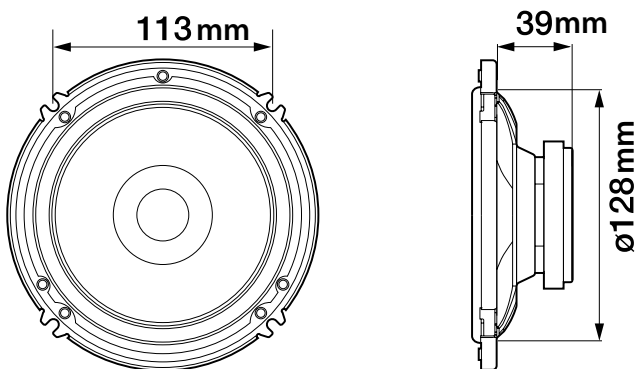

For more information please visit  
[www.pioneer-mea.com](http://www.pioneer-mea.com)

Year of Release: 2016

Pioneer, Gulf Free Zone Dubai, U.A.E.  
Tel: +971 4 8815756, Fax 8816414  
Email: [support@pioneer-uae.com](mailto:support@pioneer-uae.com)  
[www.pioneer-mea.com](http://www.pioneer-mea.com)

Corporate web : [www.pioneer.jp](http://www.pioneer.jp)

Copyright Info: ©2016 Pioneer MEA. All Rights Reserved. Reproduction in whole or in part without written permission is prohibited. Design, Features and Specifications are subject to change without notice.

