

10 cm 2-way speaker 210 W MAX.



Key Selling Point

- Mica-reinforced IMPP cone reproduces natural sound with impressive bass.
- Shallow mounting depth and comprehensive lineup allow for wide applications.
- Universal cosmetic design suits a variety of automobile interior colors.

Speaker Technology

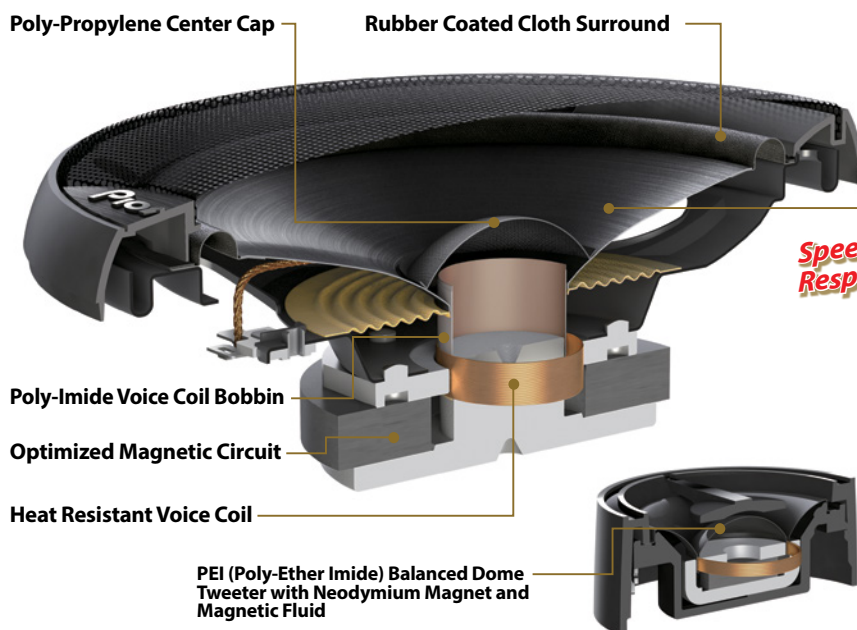

Mica Reinforced IMPP Cone

The mica is mixed into the cone material in precise proportions to optimize cone rigidity and to reproduce impactful bass.

Speedy Response!

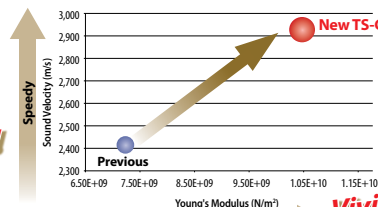

Vivid Sound!

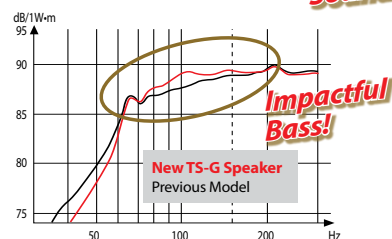

Impactful Bass!

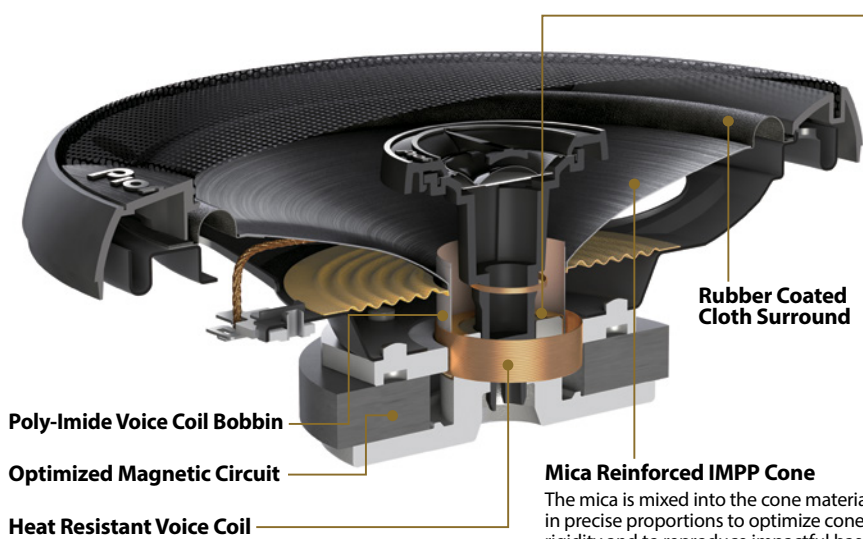

OFC Short Ring

Reduces a distortion, and expands a high frequency range.

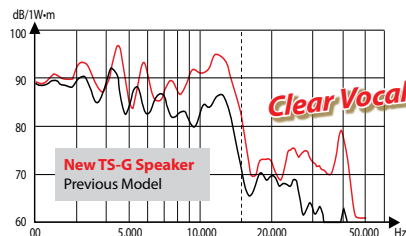
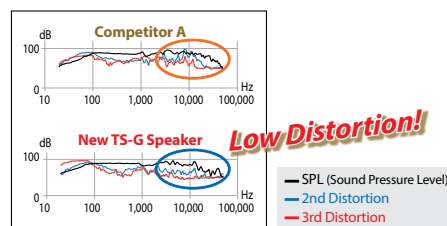

Main Specifications

Max music power output	Nominal music power output	Frequency Response	Sensitivity	Impedance	Size
210 W	30 W	38 Hz to 29KHz	84 dB	4Ω	10cm

Dimension

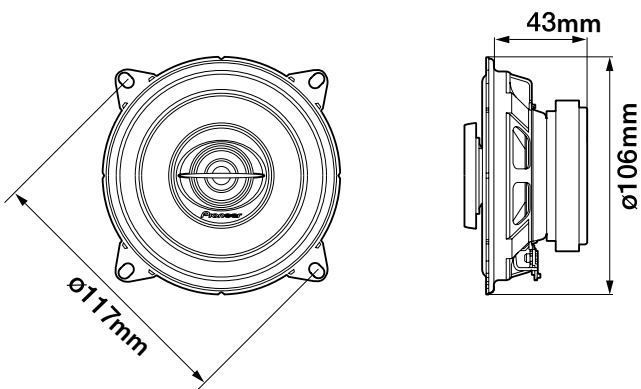

For more information please visit
www.pioneer-mea.com

Year of Release: 2016

Pioneer, Gulf Free Zone Dubai, U.A.E.
 Tel: +971 4 8815756, Fax 8816414
 Email: support@pioneer-uae.com
www.pioneer-mea.com

Corporate web : www.pioneer.jp

Copyright Info: ©2016 Pioneer MEA. All Rights Reserved. Reproduction in whole or in part without written permission is prohibited. Design, Features and Specifications are subject to change without notice.

